

JVC

COLOR VIDEO CAMERA

TK-C9200U
TK-C9200E
TK-C9201EG
TK-C9300U
TK-C9300E
TK-C9301EG

INSTRUCTIONS

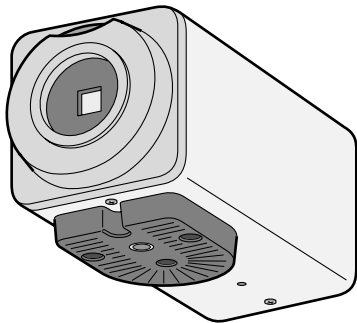

For Customer Use:

Enter below the Serial No. which is located on the body. Retain this information for future reference.

Model No. TK-C9200U,TK-C9200E,TK-C9201EG
TK-C9300U,TK-C9300E,TK-C9301EG

Serial No. _____

Introduction

Contents

Introduction

Contents	2
Features	3
Operating Precautions	4

Connection/Installation

Mounting the Lens	6
Connection	7
Mounting the Camera	9

Setting/Adjustment

Switch Settings	11
Adjusting the Back Focus	12
Fine-tuning the Focus	13
Adjusting the Auto White Balance	14

Others

Specifications	15
----------------------	----

Thank you for purchasing this product.

Before use, please read this "INSTRUCTIONS" and the information materials included to ensure proper use of this product.

The instructions in this manual are for TK-C9200U/TK-C9200E/TK-C9201EG/TK-C9300U/TK-C9300E/TK-C9301EG.

Features

- Wide dynamic range (WIDE-D) function (TK-C9300U/TK-C9300E/TK-C9301EG only)
- DAY/NIGHT surveillance with auto IR cut filter on/off (Color/B&W shooting) (TK-C9300U/TK-C9300E/TK-C9301EG)
Easy DAY/NIGHT function (TK-C9200U/TK-C9200E/TK-C9201EG)
- 3D noise reduction (3DNR)
- 4 areas privacy mask
- Built-in display mode (CRT or LCD selectable)

How to read this manual

Conventions and symbols

Note : Indicates operating precautions.

Memo : Indicates reference data regarding limitations on functions, usage and the like.

 : Indicates a reference page or item.

Contents of this manual

- JVC holds the copyright to this manual. Any part or all of this manual may not be reproduced without prior consent from the company.
- Product names of other companies described in this manual are trademarks or registered trademarks of the respective companies. Symbols such as TM, [®], and [©] are omitted in this manual.
- Design, specifications and other contents described in this manual are subject to change for improvements without prior notice.

Operating Precautions

■ Storage and Location of Use

- Do not install the camera in the following places.
 - In a place exposed to rain or moisture.
 - In a place with vapor or oil, for example in a kitchen.
 - When the ambient temperature rises above or falls below the acceptable range (from -10 °C to 50 °C)
 - In a place at which corrosive gases are emitted.
 - Near a source of radiation, X-rays, strong radio waves or magnetism.
 - In a place subject to vibration.
 - In a place with excessive dirt.
- Using this unit in the vicinity of the transmitting antenna of a radio or TV, devices that emit strong electromagnetic waves such as a transformer or motor, or wireless devices such as a transistor or mobile phone may give rise to noises in the image and changes in its color.
- This camera has been designed for indoor use. When using it outdoors, it is necessary to use an outdoor camera housing (optional).

■ Maintenance

- Wipe the camera with a dry, soft cloth to remove any dirt.
Do not use benzene or thinner to wipe the camera. Doing so may melt the surface or cause it to fog. For tough stains, wipe with a neutral detergent diluted with water, followed by wiping with a dry cloth.

■ Energy Conservation

- When the camera is not in use for a long time, turn off the power for safety and energy conservation reasons.

■ Copyright Protection

- With the exception of the user being the copyright holder or when permission such as for duplication has been granted by the copyright holder, permission is required in principle for the duplication, modification, or transmission of copyrighted material.
- Unauthorized duplication, modification, or transmission of copyrighted material may constitute a copyright infringement, and the user may be liable to compensate for any damages. When using copyrighted material, be sure to check the license agreement of the copyrighted material thoroughly.
- When rights or rights holders are involved with regard to the targeted duplicating subject, permission may be required for shooting or using (processing) it. Be sure to check the licensing conditions thoroughly.

■ Disclaimer

- Motion detection is not a feature to prevent theft or fire. We do not accept liability for any damages that may occur.

- We will not be responsible for any inconveniences or disturbances caused in the event of privacy invasion as a result of camera footages of this product.

■ Others

- When using this camera with [AGC] set to "MID" or "HIGH", the sensitivity increases automatically for dark images and the screen may appear grainy, but this is not a malfunction.
- When the DAY/NIGHT switch is set to "AUTO", the image turns black-and-white in a dark location. As the sensitivity level is increased in this case, the screen may appear grainy and more white spots may appear. When switching between modes, the brighter area on the screen is emphasized and visibility may be reduced. However, this is not a malfunction.
- Before mounting the camera to the mounting location, attach the lens to be used on the camera and check the back focus.
- When shooting an extremely bright object (e.g. lamp), the image on the screen may have white vertical tailings (smear) or expansion (blooming) may appear around it. This is a characteristic of the CCD and not a malfunction.
- When the white balance of this camera is set to "ATW-N" or "ATW-W" and depending on the conditions of the object, the color tone may differ slightly from the actual color due to the principle of the automatic tracking white balance circuit. This is not a malfunction.
- When this camera is used under high temperatures, vertical stripes may appear on the screen. This is a characteristic of the CCD and not a malfunction.
- When this camera is moved from a cold to warm place, condensation may occur and the camera may not work. In this case, leave the camera under room temperature for about one hour before turning on the power.
- When the power supply voltage is momentarily disrupted or drops due to lightning, turning on the air-conditioner or the like, image distortion or noise may occur.
- When the power supply voltage of the camera drops, the input protection circuit inside the camera operates, and the camera may be turned off. Make use of a voltage rating within $\pm 10\%$ for the camera's power supply voltage.
- The 3D noise reduction function of this camera may result in afterimage of a moving subject. Afterimage is more likely to occur when using the camera with [DNR LEVEL] set to "HIGH". This is not a malfunction.

Mounting the Lens

1 Check the mounting method of the lens before mounting.

This camera is compatible with CS-mount lens.

To use a C-mount lens, a C-mount adapter is necessary. For details about the C-mount adapter, consult your JVC dealer.

Never use a lens that exceeds the dimension (a) in the below figure as it will damage the inner part of the camera and will not allow normal installation. This will result in a malfunction.

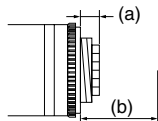

Flange back (b)	Dimension (a)
12.5 mm	5.5 mm or less

2 Turn the lens clockwise and mount it securely on the camera.

3 In the case of a DC IRIS lens, check the pin arrangement and connect the lens cable to the socket.

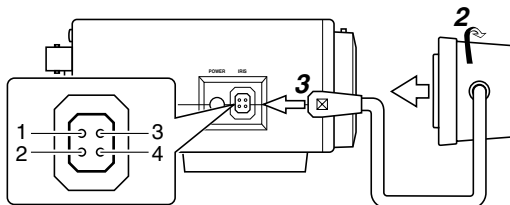

Memo • Video IRIS lens cannot be used.

- If the plug of the lens cable is different, connect with a 4 pin plug. For details about the 4 pin plug, consult your JVC dealer.

4 pin plug

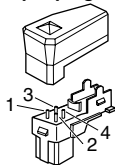

Pin number	DC IRIS lens
1	Brake (-)
2	Brake (+)
3	Drive (+)
4	Drive (-)

Connection

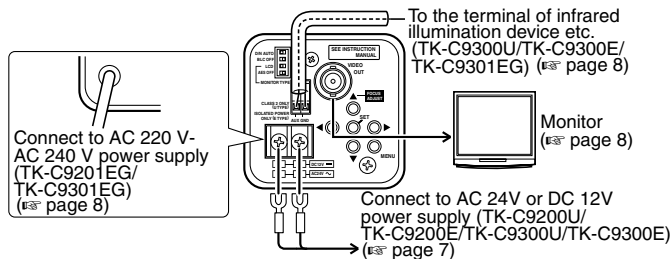

Connecting the Power Supply Cable

When power is supplied to the camera, the [POWER] lamp on the side panel lights up.

■ AC24 V or DC12 V (TK-C9200U/TK-C9200E/TK-C9300U/TK-C9300E)

To prevent connection errors or a cable disconnection, use a lug plate to connect to the terminal. The following table shows the connection distances when 2-core VVF (vinyl-insulated vinyl sheath cables) are used. (Reference value)

Conductor diameter (mm)	Φ 1.0 and more	Φ 1.6 and more	Φ 2.0 and more
Maximum connection distance: DC 12 V	50 m	140 m	220 m
Maximum connection distance: AC 24 V	130 m	350 m	550 m

Memo

- If thin cables are used, the resistance of the cables will be high and a significant voltage drop will occur when the camera is at its maximum power consumption. Either use a thick cable with low resistance or place the power supply near to the camera and shorten the length of the cable to restrict the voltage drop at the rated current of camera to below 10 %. If voltage drop occurs during operation, the performance will be unstable.
- Do not connect an AC 24 V cable to a commercial power supply. If it is connected by mistake, the internal circuit may be damaged. Send the camera to the nearest JVC service center for inspection as the internal circuit may be damaged.

Connection/Installation

Connection (Continued)

- Memo**
- Do not connect DC 12 V and AC 24 V cables at the same time.
 - When using a DC 12 V power supply, ensure that the polarities of the cable are correct.

■ AC 220 V - AC 240 V (TK-C9201EG/TK-C9301EG)

When using this camera, install it near the socket so that power disconnection may be made immediately.

Connecting the Monitor

Connect with a 75 Ω coaxial cable (BNC) such as RG-59.

Connecting the Alarm Input/Output Terminal (TK-C9300U/TK-C9300E/TK-C9301EG only)

Menu settings may be required depending on the connected equipment. (Refer to [AUX FUNCTION] in the separate "MENU SETTING".)

The default setting has been set to alarm input (IN:ALARM).

■ Alarm input terminal

Connect the infrared sensor, door sensor, metal sensor, manual switch sensor and the like.

- To prevent noise from entering the internal circuit, supply non-voltage setting signal to the alarm input signal.
- Do not supply voltage.
- Using the menu, you can select whether to set to alarm when the contact is short (MAKE), or when the contact is open (BREAK).
- Supply such that the alarm signal stays at a minimum of 200 ms or more. Otherwise, the alarm signal may not be recognized.

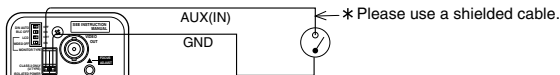

■ Alarm output terminal

Connect to alarm devices such as alarm, indicator, light or buzzer.

- The alarm output signal is open collector output and turns ON during an alarm. (Maximum voltage 16 V, current 30 mA)
- This terminal has a polarity. Make sure to connect such that a higher voltage is output from the + terminal than from the - terminal. Otherwise, it will result in damages.

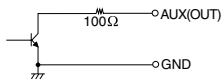

Mounting the Camera

When mounting the camera on a fixer, pan/tilt and the like, use the camera-mounting screw hole located on the camera-mounting bracket. (Length of screw: 7 mm or less)

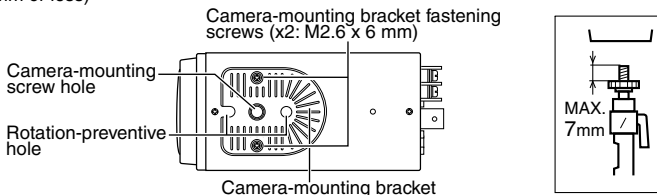

Note Use a camera-mounting screw with a length shorter than 7 mm from the camera-mounting face. Use camera-mounting bracket fastening screws with length shorter than 6 mm. Do not use a screw that is longer than the specified length. It may damage the internal parts.

■ Mounting the Camera-Mounting Bracket on Top of the Camera

The camera-mounting bracket is originally mounted at the bottom of the camera before shipment but it can also be mounted on top of the camera.

- 1 Remove the camera-mounting bracket fastening screws (x2).**
The camera-mounting bracket is removed from the camera.
- 2 Mount the camera-mounting bracket on top of the camera.**
- 3 Mount the camera onto a fixer, pan/tilt unit and the like.**

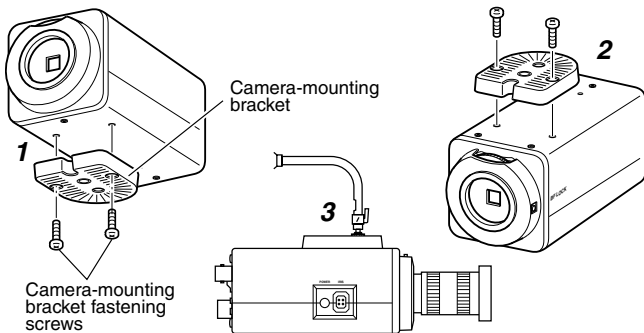

Mounting the Camera (Continued)

■ Fall Prevention

- Special attention is required when installing the camera to the wall or ceiling. You should not engage in the installation work yourself. Ask a professional to do the job, because injuries and accidents may occur if the camera falls.
- When installing the camera on a fixer, pan/tilt unit and the like, make sure to install it firmly using a rotation-preventive hole to prevent fall.
- To prevent fall, connect the camera to a section with sufficient strength (ceiling slab or channel) using a fall prevention wire.
- Pay attention to the length, strength, routing and material (insulation properties) of the fall prevention wire used.
- Use the screw (M3 x 6 mm) on the back of the camera for the installation of the fall prevention wire. Do not use a screw that is longer than 6 mm as it may damage the internal parts.

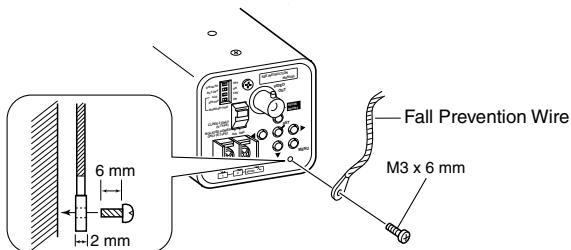

Note When mounting the camera to the ceiling, ensure to wear safety glasses to protect the eye from any falling objects.

Switch Settings

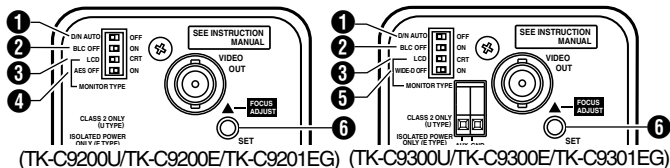

(TK-C9200U/TK-C9200E/TK-C9201EG) (TK-C9300U/TK-C9300E/TK-C9301EG)

① [D/N AUTO/OFF] DAY/NIGHT Selector Switch

Set this to "AUTO" when shooting a subject with continually changing brightness (day/night). The image switches to color when the subject is bright, and black and white when it is dark. The image is set to color at all times when "OFF" is selected. You can set the image to black and white at all times using the menu. (TK-C9300U/TK-C9300E/TK-C9301EG only)

(Default setting: AUTO)

② [BLC OFF/ON] Backlight Compensation Selector Switch

Set this to "ON" when shooting in backlight. The subject becomes easier to see as brightness is adjusted according to the photometry area set in [BLC AREA] of the menu. (Default setting: OFF)

③ [MONITOR TYPE LCD/CRT] Monitor Type Selector Switch

Set this to "LCD" or "CRT" according to the monitor in use.

(Default setting: LCD)

④ [AES OFF/ON] AES Selector Switch (TK-C9200U/TK-C9200E/TK-C9201EG)

When this is set to "ON", automatic electronic shutter is activated and the shutter speed switches according to brightness automatically. When set to "OFF", the shutter speed will be fixed. (U model: 1/60, E/EG model: 1/50)

(Default setting: OFF)

Memo For automatic iris lens, the optimum image may not be obtained due to conditions such as brightness of the subject. Set this to "OFF" when using an automatic iris lens.

⑤ [WIDE-D OFF/ON] WIDE-D Selector Switch (TK-C9300U/TK-C9300E/TK-C9301EG)

When this is set to "ON", subjects with a high contrast can be seen clearly and naturally.

(Default setting: OFF)

⑥ [FOCUS ADJUST] Focus Adjust Button

Press and hold the ▲ button to open the lens iris for easy focusing. (☞ page 13)

Adjusting the Back Focus

This camera is adjusted to an optimum wide range before shipment but readjustment is required when using zoom lens or when the lens focus ring is out of focus.

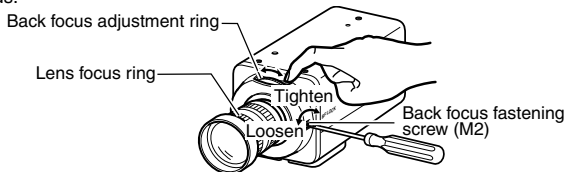

■ With a Fixed-Focus Lens

If the focus cannot be adjusted correctly with the lens focus ring, adjust the back focus as follows.

- 1 Loosen the back focus fastening screw by turning it anti-clockwise with a + screwdriver.
- 2 Shoot some fine patterns on the subject or away from the subject.
- 3 Turn the lens focus ring to ∞ .
- 4 Turn the back focus adjustment ring to get the best focus.
- 5 Tighten the back focus fastening screw by turning it clockwise.

■ With a Zoom Lens

If the image is out of focus when zooming (telephoto - wide angle), adjust the camera as follows.

- 1 Loosen the back focus fastening screw by turning it anti-clockwise with a + screwdriver.
- 2 Shoot some fine patterns on the subject or away from the subject.
- 3 Zoom to the maximum telephoto position and turn the lens focus ring to adjust the focus.
- 4 Zoom to the maximum wide angle position and turn the back focus adjustment ring to adjust the focus.
- 5 Repeat steps 3 and 4 two or three times.
- 6 Tighten the back focus fastening screw by turning it clockwise.

- Memo**
- When the subject is bright and an ND filter is used, back focus adjustment can be performed more accurately. (An ND filter is a filter that reduces light incident on the lens of all wavelengths equally.)
 - Use the focus adjust mode for easy focusing. (☞ page 13)

Fine-tuning the Focus

When adjusting the focus of the DC IRIS lens, use the Focus Adjust mode for easy focusing as the iris opens and depth of field becomes shallower. (Refer also to the instruction manual of the lens.)

■ Procedure

1 Press and hold the [▲] button.

The Focus Adjust mode is activated and "FOCUS ADJUST MODE" appears on the screen.

Contours are emphasized as the iris opens.

2 Shoot the subject.

3 Adjust the focus of the DC IRIS lens.

4 Exit the Focus Adjust mode.

Press any of the [▼, ◀, ▶]/[SET]/[MENU] buttons to cancel the Focus Adjust mode. The mode is also automatically deactivated after about 30 seconds.

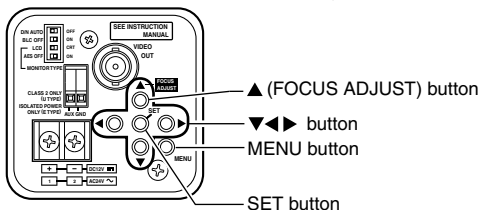

Adjusting the Auto White Balance

Each light source has its own color temperature. Therefore, when the main light source lighting the subject is changed, adjust the white balance again.

1 Press the [MENU] button.

2 Select [WHITE BALANCE] with the [▲/▼] button and "AWC" with the [◀/▶] button, then press the [SET] button.

3 Zoom in to fill the screen with white.

Place a white object at the center of the screen, under the same lighting condition as the subject to be shot and zoom in to fill the screen with white.

4 Press the [SET] button.

Auto white balance adjustment begins. During operation, "AWC OPERATION" is displayed on the screen.

5 Adjustment is complete.

When the appropriate white balance is acquired, "AWC OK" is displayed.

SET button ▲▼◀▶ button

MENU button

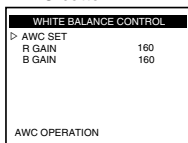
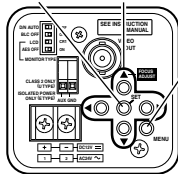

AWC OPERATION
(during operation)

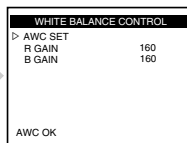

AWC OK
(adjustment completed)

■ Error display

If auto white balance adjustment is not successful, the following messages will appear on the monitor.

- AWC ERROR : NG (Subject error)

Displayed when there is not enough white color on the subject or the color temperature is not suitable.

Fill the screen with a white object thoroughly and adjust the white balance again.

- AWC ERROR : LOW LIGHT (Insufficient illumination)

Displayed when the light is low. Increase the illumination, then readjust the white balance.

- AWC ERROR : HIGH LIGHT (Excessive illumination)

Displayed when the light is too bright. Decrease the illumination, then readjust the white balance.

- AWC ERROR : TIME OVER (Subject movement)

Displayed when the subject moves. Keep the subject still, then readjust the white balance.

Specifications

Horizontal resolution	: 600TV lines *
Video S/N ratio	: 52 dB (typical, AGC OFF)
Minimum illumination	: (TK-C9300U/TK-C9300E/TK-C9301EG) Color mode: 0.05 lx (typical, 50 %, F1.2, AGC HIGH) Black and white mode: 0.002 lx (typical, 50 %, F1.2, AGC HIGH) (TK-C9200U/TK-C9200E/TK-C9201EG) Color mode: 0.05 lx (typical, 50 %, F1.2, AGC HIGH) Black and white mode: 0.03 lx (typical, 50 %, F1.2, AGC HIGH)
Lens mount	: CS-mount
Power supply	: AC 24 V 60 Hz, DC 12 V (TK-C9200U/TK-C9300U) AC 24 V 50 Hz/60 Hz, DC 12 V (TK-C9200E/TK-C9300E) AC 220 V - AC 240 V 50 Hz/60 Hz (TK-C9201EG/TK-C9301EG)
Length of power supply cable	: 1,900 mm (TK-C9201EG/TK-C9301EG)
Current/power consumption	: 2.3 W (TK-C9200U) 190 mA (TK-C9200E) 37 mA (TK-C9201EG) 2.5 W (TK-C9300U) 220 mA (TK-C9300E) 40 mA (TK-C9301EG)
Ambient temperature	: -10 °C to 50 °C (14 °F to 122 °F) (Operation) 0 °C to 40 °C (32 °F to 104 °F) (Recommended)
Mass	: 280 g (TK-C9200U/TK-C9200E/TK-C9300U/TK-C9300E) 470 g (TK-C9201EG/TK-C9301EG)
Accessories	: (TK-C9200U/TK-C9300U) WARRANTY CARD × 1 INSTRUCTIONS × 3 (TK-C9200E/TK-C9201EG/TK-C9300E/TK-C9301EG) INSTRUCTIONS × 5
Dimension (W×H×D)	: mm (inch) 55 (2-3/16) × 61 (2-7/16) × 126 (5)

- Specifications and appearance of this unit are subject to change for further improvements without prior notice.

TK-C9200U/TK-C9200E/
TK-C9201EG/TK-C9300U/
TK-C9300E/TK-C9301EG
COLOR VIDEO CAMERA

JVC