

JVC[®]

The Perfect Experience / —

ProHD

HD Memory Card Camera Recorder

GY-HM700U

Seamlessly Integrated



The above picture shows the GY-HM700U with the optional battery.

GY-HM700U

At Last, a Pro Camcorder that Speaks the Same Language as Your Editing System

The world's first native support for Final Cut Pro™

Introducing the GY-HM700U, the world's first professional camcorder that natively records Apple's QuickTime™ (MOV) file format for Final Cut Pro™. Forget transcoding and file wrapping – recorded files can be read directly into Apple's popular editing system for a workflow that's fast and smooth, with absolutely no loss of quality. And for compatibility with other NLE systems, the GY-HM700U also supports the MP4 file format.

Recording to twin SDHC memory cards, the GY-HM700U represents a new generation of camcorders that make continuous HD shooting and seamless software integration a reality.

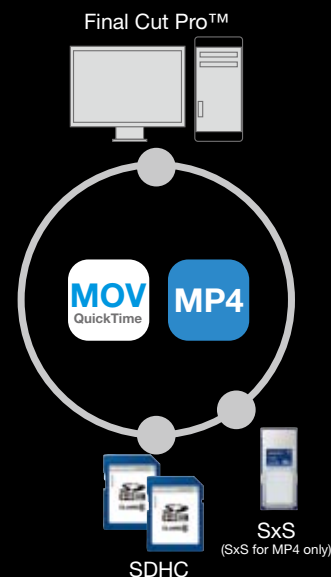



Native File Recording

Record footage directly in ready-to-edit QuickTime™ MOV files, the native file format of Apple's Final Cut Pro™. Simply drag the files into the timeline and start editing. Alternatively, you can record MP4 files that are compatible with all major editing systems when used with optional SxS media recorder.



Reliable, Low-cost Media

The GY-HM700U uses standard, inexpensive and widely available SDHC Class 6 memory cards. These cards are small, light, robust and reliable, and can be read by your computer using any standard card reader. Also with the optional SxS media recorder, simultaneous shooting to SDHC and SxS memory is possible, providing an instant client copy and reliable backup solution.



The Choice of Broadcasting and Cinematography Professionals

Drawing on its long experience of developing dedicated encoders for the broadcasting industry, JVC has equipped the GY-HM700U with a brand new MPEG2 encoder capable of compressing full 1920 x 1080 HD video at up to 35 Mbps. The result is the pristine picture quality that professional users demand, from a surprisingly compact and lightweight shoulder-mount camcorder.



Workflow

With Native File Recording, JVC has eliminated one of the main obstacles to achieving a smoother, more streamlined production workflow. Until now, getting footage into a file format that computer-based editing systems could work with was a time consuming process. With Native File Recording, your footage is ready to edit the moment it's shot.



35
Mbps

Exceptional Image Quality

Encoding video at higher bit-rates means just one thing: higher image quality. The 35 Mbps data rate used by the GY-HM700U is high enough to support full 1920 x 1080 encoding, and results in stunningly detailed, broadcast-standard HD images.

JVC's newly developed 1080p Dynamic Digital Signal Processor (DDSP), is the engine that encodes the high bit-rate video signal into an MPEG2 stream and acts as a file compiler for QuickTime™ and MP4 files.

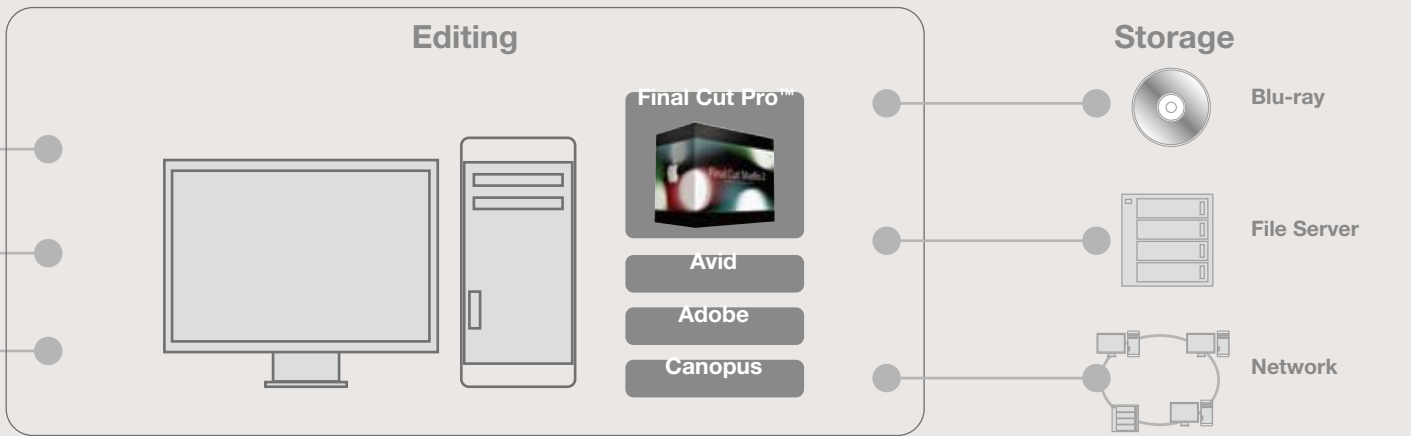

Photo courtesy of WXYZ-TV(ABC, Detroit)

Photo courtesy of DirtyPoliticsTheMovie.com

Photo courtesy of DirtyPoliticsTheMovie.com

Photo courtesy of Waterman Broadcasting Corp.



Absolute Flexibility in a Compact Shoulder Camcorder GY-HM700U

LCOS Viewfinder

The GY-HM700U features a stunning new 16:9 aspect ratio LCOS (Liquid Crystal on Silicon) viewfinder. Thanks to its high resolution, the LCOS viewfinder is crisper and more detailed than conventional LCD viewfinders.



Canon 14x HD Lens

The GY-HM700U comes with a new, high-performance 14x HD lens from Canon, based on the superb optics found in more expensive HD lenses. From wide angle through to telephoto, the lens has pin-sharp focusing accuracy and constant image brightness with no F-drop.

Three 1/3-inch Progressive CCD Design with Triplex Offset

High definition is all about image quality. The newly designed 1/3" progressive CCDs together with JVC's original Triplex Offset and an Adaptive Pixel Correlation Technology that produces resolution and color comparable to cameras with larger image sensors.

1080p Dynamic Digital Signal Processor (DDSP)

JVC's new 1080p Dynamic Digital Signal Processor is the engine that drives the GY-HM700U. This highly efficient MPEG2 encoder processes video signals at up to 35 Mbps for full 1920 x 1080 progressive or interlace video.

Twin SDHC Card Slots

The GY-HM700U gives users the flexibility of twin SDHC memory card slots. When one card is full, the camcorder switches automatically to the other card with no drop out, making possible true continuous shooting. Memory cards are hot swappable, so cards can be removed for editing without interrupting the shoot. For even greater flexibility, the optional SxS media recorder makes possible simultaneous recording to both SxS and SDHC media.



4.3-inch LCD Monitor

The large 16:9 aspect ratio LCD monitor and redesigned GUI bring ease of use to a new level for a professional camcorder.

Innovation that Meets the Needs of Professionals

The Next Generation of Direct File Access

Native File Recording (QuickTime™ for FCP™)

The GY-HM700U uses QuickTime™ as its native file format for the tightest integration yet with Apple's popular Final Cut Pro™ editing system. Simply drag the QuickTime™ MOV files recorded on the memory card into Final Cut Pro™ and you're ready to start editing—no file wrapping, no transcoding, no waiting.

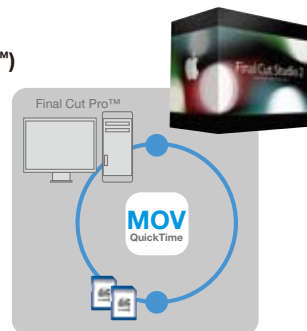

Twin SDHC Card Slots with Seamless Continuous Recording

Loaded with two 32 GB cards, the GY-HM700U is good for over six hours* of continuous HD shooting across both cards. When one card is full, the camcorder switches seamlessly and automatically to the other card. And because cards are hot swappable, there is in effect no limit to the continuous shooting time in any mode, even with inexpensive lower capacity cards—just keep loading new cards. Hot swappable media also means it is possible to start editing footage from one card while still shooting to the other. The twin card slots also offer the flexibility of scene-by-scene card selection.

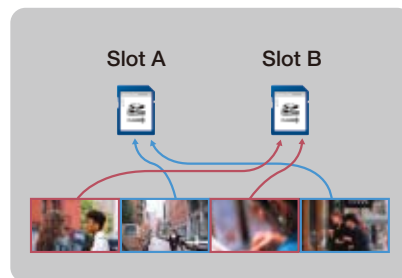
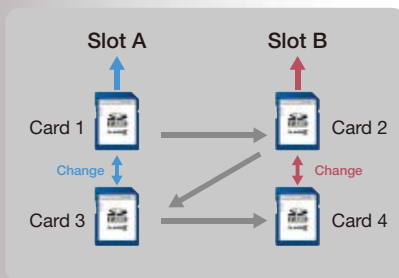

SDHC media offers the best combination of price, availability, capacity, reliability and transfer speed. With no moving parts and no pins or other extrusions, SDHC cards are both durable and reliable, and compare favorably with tape on a cost-per-minute basis.

* In 19 Mbps mode

SxS Double Media Hybrid Recording (Optional)

The optional SxS media recorder allows simultaneous shooting to SDHC and SxS media. This hybrid recording system not only provides a reliable backup solution, it also allows the GY-HM700U to integrate smoothly into any MP4 file-based workflow. This file format is compatible with major NLE systems, including solutions from Adobe, Avid and Canopus.



* Playback compatibility not guaranteed on all products due to variation of supported recording mode.
* MP4 is the compliant file format used on the XDCAM EX.
* SxS is a flash memory card designed for professional video cameras with a high-speed PCI Express interface.
* All trademarks and brand names are the property of their respective proprietors.

Advanced MPEG2 High Bit Rate Encoding

1080p Dynamic Digital Signal Processor (DDSP)

At the heart of the GY-HM700U is the new Dynamic Digital Signal Processor. Processing is performed on the full progressive 1920 x 1080 signal, regardless of the camcorder's settings, ensuring the highest picture quality in any shooting mode. All major HD resolutions are supported, including 1920 x 1080, 1440 x 1080 and 1280 x 720.



35 Mbps MPEG2 Encoding

The highly efficient MPEG2 codec used by the Dynamic Digital Signal Processor compresses video signals at up to 35 Mbps—high enough to support 1920 x 1080 resolution—for simply stunning image quality. The MPEG2 long GOP (Group of Pictures) codec is a widely used, broadcast-standard compression system and is supported by all popular editing systems and broadcast servers.



35 Mbps		25 Mbps	19 Mbps
1920 x 1080/60i	1280 x 720/60p	1440 x 1080/60i	1280 x 720/60p
1920 x 1080/50i	1280 x 720/50p	1440 x 1080/50i	1280 x 720/50p
1920 x 1080/30p	1280 x 720/30p		1280 x 720/30p
1920 x 1080/25p	1280 x 720/25p		1280 x 720/25p
1920 x 1080/24p	1280 x 720/24p		1280 x 720/24p
1440 x 1080/60i (MOV only)			
1440 x 1080/50i (MOV only)			

Uncompressed Audio Recording with Full Manual Control

The GY-HM700U captures audio with the same uncompromising quality as video. Two-channel 16-bit/48 kHz uncompressed linear PCM can be recorded via the detachable shotgun microphone, or via a pair of balanced XLR connectors. Versatile input switching and independent channel assignment allow both mic and line-level sources (such as wireless receivers) to be connected, and phantom power is available on each XLR connector independently. Audio recording levels can be controlled automatically or manually, with an audio meter in the viewfinder and LCD monitor for easy monitoring.



Best-in-Class High Resolution HD Recording

Newly Developed Canon 14x HD Lens

The JVC GY-HM700U comes equipped with a newly developed 14x interchangeable HD lens from Canon. With a focal length down to 4.4 mm (equivalent to 31.7 mm on a 35 mm camera), the new lens is 20% wider than previous models, and at the telephoto end (up to 447 mm at 35 mm equivalent) it is less susceptible to color flaring. Throughout the zoom range the lens produces less chromatic aberration for more accurate focusing, and the same image brightness without reducing the F-stop.



Three 1/3-inch Progressive CCD Design with Triplex Offset

The three progressive CCD design provides rich, accurate colors, while JVC original Triplex Offset technology in conjunction with pixel correlation adaptively increases the effective resolution both horizontally and vertically by shifting the red and blue pixels independently relative to the green for a sharper picture without any corresponding loss in sensitivity. As a result, horizontal, vertical and diagonal resolutions are dramatically increased.

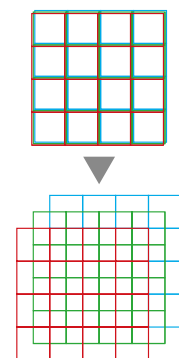
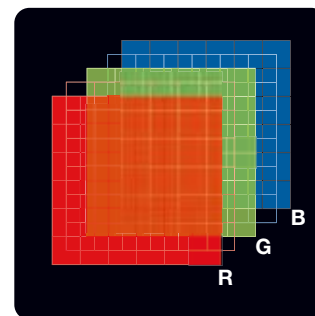

Triplex Offset

Ease of Operation for Complete Creative Freedom

1.22 Megapixel LCOS Viewfinder and Focus Assist Function

The GY-HM700U features a stunning new high-resolution (852 x 480 x 3) LCOS (Liquid Crystal on Silicon) 0.45" viewfinder. The 16:9 aspect ratio image is crisper and more detailed than conventional LCD viewfinders, with higher vertical resolution and superior RGB color separation. Helping the camera operator stay focused on the action is a focus assist system that colors the edges of the parts of the image that are in focus. Also visible in the viewfinder are indicators for the audio input level, the battery time remaining, and the recording time available on each memory card.

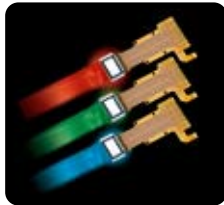

4.3-inch LCD Monitor

The large, high-resolution 4.3-inch 16:9 aspect ratio LCD monitor provides a wide array of monitoring and setup indications. The monitor's 800 x 480 WVGA resolution, together with the easy-to-use cross keys for GUI navigation, bring ease of use to a new level for a professional camcorder.



GUI

The new GUI features several improvements that make the GY-HM700U a pleasure to use. All on-screen monitors can be navigated intuitively via a four-way cross key and a central Set button. A colored LED ring illuminates the outer edge of the cross keys, indicating the current camera mode. The GUI can be viewed in both the LCD monitor and overlaid in the viewfinder.



The high-resolution picture thumbnail display makes it a simple task to select clips visually for review, and more detailed file and shooting information for each clip is now available, including the file format, frame rate and resolution, time code data and more.



Shooter-Friendly Controls and Layout

The control panel of the GY-HM700U has been laid out so that all commonly used controls are within easy reach of the operator while shooting. Among the controls are three user-definable buttons that can be assigned a range of functions for instant setting.



Pre Rec Mode

How many times have you missed a crucial moment because you didn't hit the record button in time? With Pre Rec enabled, the camcorder continuously buffers about three seconds of video, so that when recording is started the cached video is included in the recorded file, giving you a three-second head start.

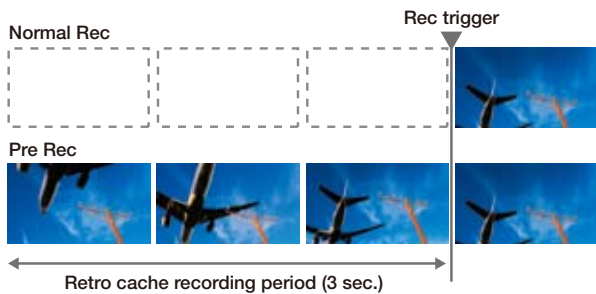

Spot Exposure Meter

When shooting high-contrast scenes, setting the exposure accurately can become tricky. The Spot Meter allows you to monitor the dynamic range of the image in various ways so that the exposure may be controlled more accurately. A manual mode allows a specific area of the image to be monitored for precise exposure control of the main subject in the frame. There are four modes of spot metering: Max/Min, Max, Min and Manual. In the Max/Min mode, the highest and lowest levels of the image are identified with color markers, red (H) and white (L), along with the video level (before knee and gamma).



Remote Camera Control Connector

The GY-HM700U is equipped with a standard JVC 6-pin TTL interface for an optional remote camera controller (RM-LP25U, RM-LP57U or RM-LP55U). These units provide extensive control options, including paint, iris, gamma level, knee, gain, shutter and black level.



Variable Frame Rate Recording (Over Crank, Under Crank)

When recording in the 720p 35 Mbps mode, the camera can be set to record at a frame rate different than the playback rate. This capability makes it possible to record slow or fast motion when the recording is played back at 24p or 30p.

Versatility and Quality of Output

SDI and IEEE1394 Output of HD and Downconverted SD Video

In addition to SD composite and HD component video output, the GY-HM700U is provided with SDI and IEEE1394 output. SDI output is via a BNC connector and can be switched between HD and downconverted SD with embedded uncompressed audio. IEEE1394 output is via a 4-pin connector and can also be switched between HD and downconverted SD. The audio output is HDV-compliant in HD mode and DV-compliant in SD mode.

Composite out



Component out

SDI out

IEEE1394 out



MOV File Workflow

Direct file access to Apple's Final Cut Pro™

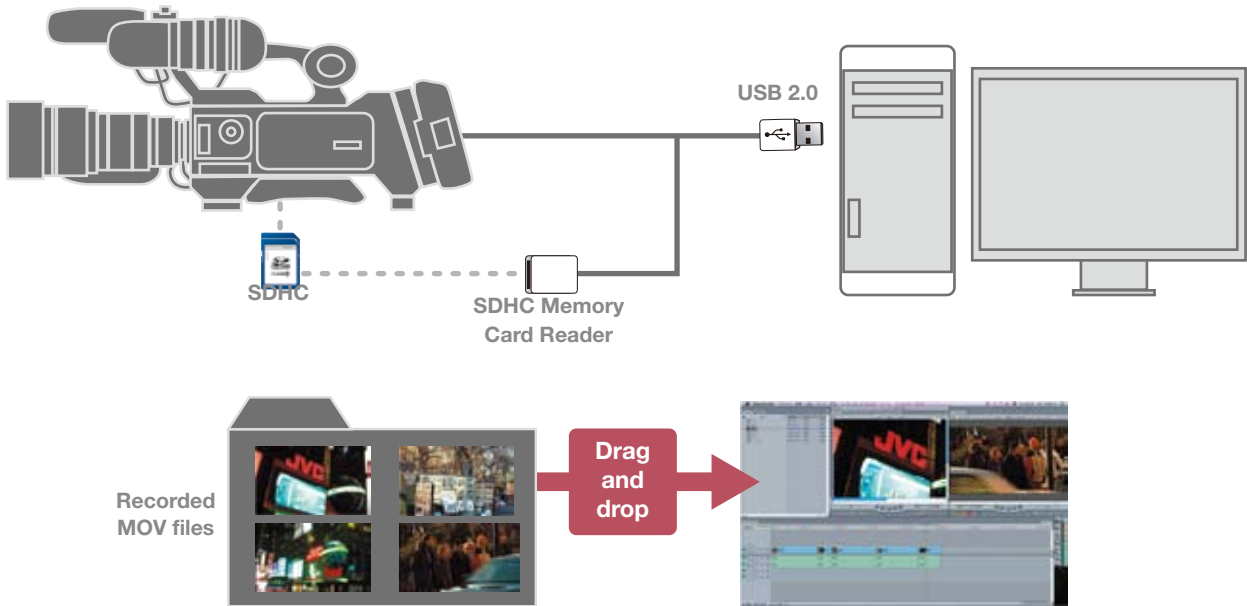

MP4 File Workflow

Ingest MP4 clips to major NLE systems

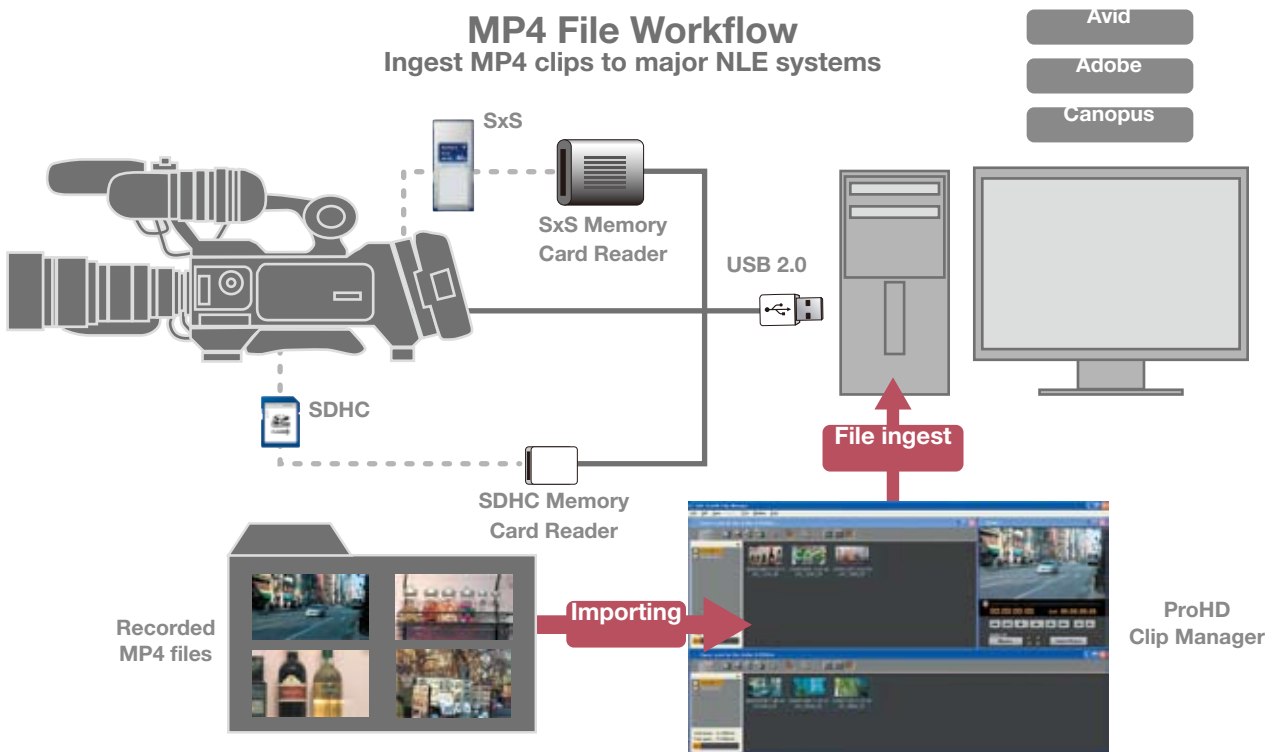

ProHD Software

JVC ProHD Clip Manager

The ProHD Clip Manager, for both Mac and Windows, makes it easy to manage MP4 clips on the GY-HM700U's memory cards from your PC. With a few clicks of the mouse you can copy, move or delete clips, preview clip content, as well as view and edit clip metadata. A thumbnail view of all the clips in the current folder shows the content of each clip at a glance. Use the viewer to watch the whole clip, or change the clip's index frame used for the thumbnail. You can also manage folders to keep your clips organized, and check the remaining free space on a card.

Main screen for Windows®



Information window

Viewer window

ProHD Log and Transfer Plug-in

The ProHD Log and Transfer Plug-in is a software for Apple's Final Cut Pro™ that lets you drop MP4 files recorded on the GY-HM700U into the clip bin of Final Cut Pro™. With the plug-in installed, you can view thumbnails of the MP4 files on a memory card from the Log and Transfer screen of Final Cut Pro™. Simply drag and drop the thumbnails into the bin to automatically convert the clips to QuickTime™ format, ready for use.

Log and transfer screen



Browser

Preview

Ingest

Logging

Dimensions

Unit: inches (mm)

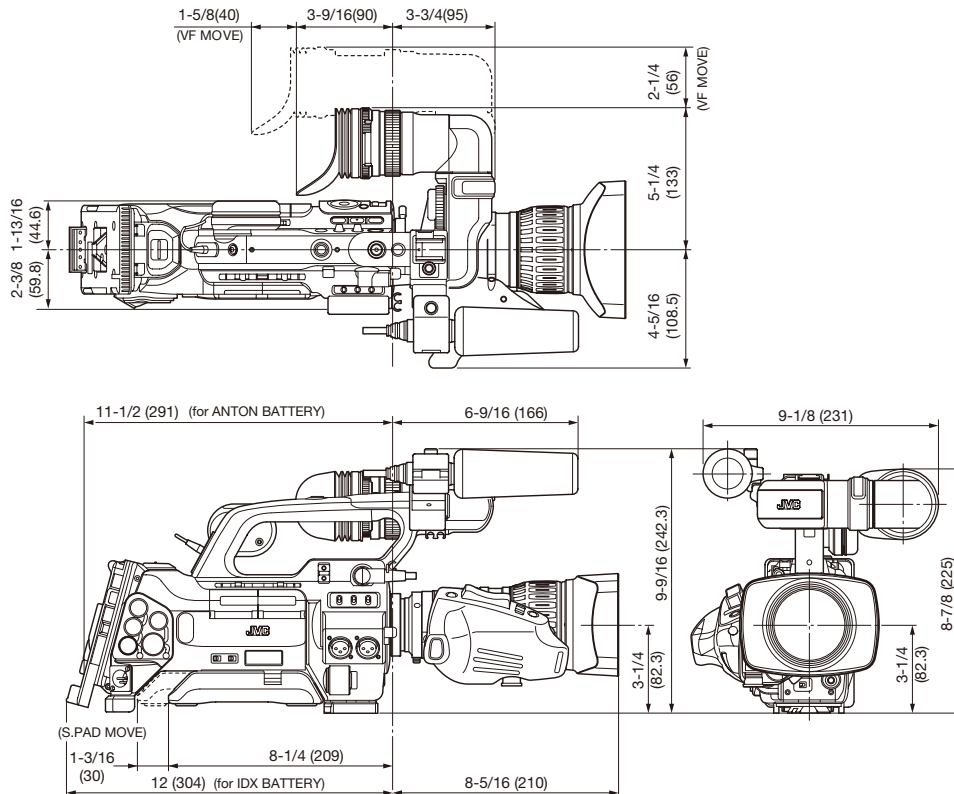

System Configuration

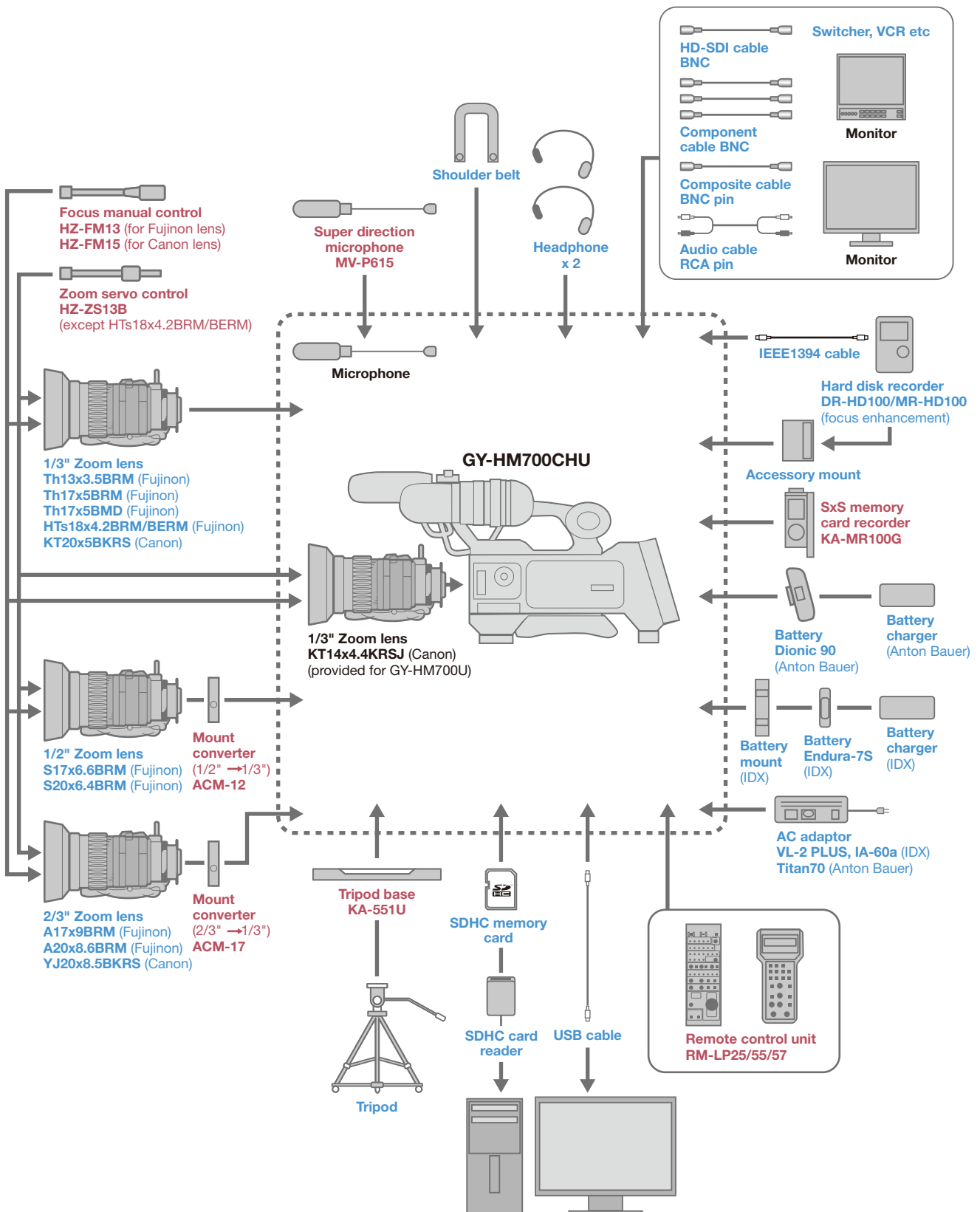

Optional Accessories



(Canon)

KT20x5BKRS

1/3" High quality zoom lens



(Fujinon)

HTs18x4.2BRM

HTs18x4.2BERM (2x extender)
1/3" High quality zoom lens



(Fujinon)

Th17x5BRM

1/3" Zoom lens



(Fujinon)

Th17x5BMD

1/3" MD Zoom lens



(Fujinon)

Th13x3.5BRM

1/3" Wide zoom lens



HZ-CA13U

16mm film lens adapter



ACM-17

2/3" Bayonet mount converter

ACM-12

1/2" Bayonet mount converter



MV-P615U

Super direction microphone



HZ-ZS13BU

Manual zoom control

Cannot be used for HTs18x4.2BRM lens.
Use Fujinon ZMM-6: Module unit/CZH-14:
Grip/CFC-12-990: Cable/MCA-7: Mounting clamp



HZ-FM13U (Fujinon)

HZ-FM15U (Canon)

Manual focus control



KA-551U

Tripod base V-mount adapter



RM-LP25U

RM-LP55U

RM-LP25U (Desk mount)

RM-LP55U (Handheld)

RM-LP57U (Desk mount)

Remote control unit

6-pin DIN



Endura-E-7S (Battery)

IDX V-mount battery



VL-2PLUS (Charger)

IDX V-mount battery charger /
AC adapter



Dionic 90 (Battery)

Anton Bauer battery



Tandem 70 (Charger)

Anton Bauer battery charger /
AC adapter



KA-MR100G

SxS memory card recorder



(Focus
enhancements)

DR-HD100GB10

Hard disk drives

For m2t or SD video file recording only.



(Focus
enhancements)

MR-HD100U

Hard disk drives

For m2t or SD video file recording only.



DT-V24L3U / V20L3U /

V17L3U / V9L1U

LCD HDTV monitor

Specifications

GY-HM700U

[General]

Power requirement: DC 12 V (11 V to 17 V)
 Power consumption: Approx. 23 W (during recording [when the camcorder + standard lens + LCD monitor are in use])
 Mass: Approx. 3.4 kg (7.5 lbs.)
 Temperature:
 Operating: 0°C to 40°C (32°F to 104°F)
 Storage: -20°C to 60°C (-4°F to 122°F)
 Humidity:
 Operating: 30% to 80% RH
 Image pickup device: 3-chip 1/3" Progressive CCD
 Color separation prism: F1.4, 3-color separation prism
 Sync system: Internal sync (built-in SSG)
 Lens mount: 1/3" bayonet system
 ND filter: OFF, +1/4ND, +1/16ND
 Gain: 0dB, 3dB, 6dB, 9dB, 12dB, 15dB, 18dB, ALC
 Electronic shutter: 1/6 to 1/10000, EEI
 Minimum illumination: 1.25lx (typical) (1920x1080 mode, F1.4, +18dB, with 8-frame accumulation)
 LCD monitor: 4.3" LCD, 800 x 480 (WVGA, 410,000 pixels)
 Viewfinder: 0.45" LCOS, 1.22 Megapixels (852 x 480 x 3)
 Lens: Canon F1.6, 14x, f = 4.4-61.6 mm (35 mm conversion: 32 to 448 mm)
 Filter diameter: 82 mm
 Supported media: SDHC (Class 6)
 Slots: x 2
 Recording time: Approx. 25 minutes (8 GB SDHC card, 35 Mbps, VBR mode)

■ SDHC Class 6 recording time (approx.)

	MOV/MP4		
	SP		HQ
	720p	1080i	720p/1080i
4GB	22 min.	17 min.	12 min.
8GB	45 min.	35 min.	25 min.
16GB	1 hr. 30 min.	1 hr. 10 min.	50 min.
32GB	3 hr.	2 hr. 20 min.	1 hr. 40 min.

[Video/Audio]

Recording file format: QuickTime™ File Format for Final Cut Pro™/MP4 File Format (w/KA-MR100)
 Recording format:
 Video: MPEG-2 long GOP
 HQ mode: VBR, 35 Mbps (Max) MPEG-2 MP@HL
 SP mode: CBR, 25 Mbps (1440x1080i)/19 Mbps (1280 x 720p24/25/30): MPEG-2 MP@H-14
 19 Mbps (1280 x 720p50/60): MPEG-2 MP@HL
 Audio: LPCM 2ch, 48 kHz/16bit
 Video frame rate:
 NTSC settings:
 HQ mode: 1920 x 1080/59.94i, 29.97p, 23.98p, 1440 x 1080/59.94i (MOV only), 1280 x 720/59.94p, 29.97p, 23.98p
 SP mode: 1440 x 1080/59.94i, 1280 x 720/59.94p, 29.97p, 23.98p
 PAL settings:
 HQ mode: 1920 x 1080/50i, 25p, 1440 x 1080/50i (MOV only), 1280 x 720/50p, 25p
 SP mode: 1440 x 1080/50i, 1280 x 720/50p, 25p
 Variable frame rate (HQ 720p mode):
 NTSC settings: 10/12/15/20/24/30/40/48/60 fps
 PAL settings: 10/12.5/20/25/40/50 fps

[Connectors]

Analog composite output (480i or 576i: Downconverted, 4:3/16:9): 1.0 V (p-p), 75-ohms, BNC (unbalanced)
 Component output (720p/1080i): Y: 1.0 V (p-p), 75-ohms Pb, Pr: 0.7 V(p-p), 75-ohms, BNC x 3 (unbalanced)
 SDI output terminal (480i or 576i: Downconverted/720p/1080i: embedded audio), BNC (unbalanced)
 HD-SDI: Compliant with SMPTE 292 M
 SD-SDI: Compliant with SMPTE 259 M
 Audio input:
 [MIC]: -60 dBu, 3k-ohms, XLR (balanced), +48 V output (phantom power supply)
 [LINE]: +4 dBu, 10k-ohms, XLR (balanced)
 Audio output: -8±1 dBu (when audio signal process output is -20 dB), 1k-ohms, RCA x 2 (unbalanced)
 Headphone: 3.5 mm mini jack (stereo) x 2
 Remote: DIN 6-pin
 IEEE1394 output: 4-pin
 USB: Mini USB-B type, USB 2.0, miniB, slave function (mass storage class) only
[Accessories Provided]
 Microphone x 1

Final Cut Pro™ is not supplied. Microsoft® and Windows® are either registered trademarks or trademarks of Microsoft Corporation in the United States and/or other countries. Apple, Apple logo, Macintosh, QuickTime, and Final Cut Pro are trademarks of Apple Inc. registered in the United States and other countries. The SD and SDHC logos are trademarks of the SD Card Association. HDV and HDV logo are trademarks of Sony Corporation and Victor Company of Japan Limited(UVC). Product and company names mentioned here are trademarks or registered trademarks of their respective owners.

Simulated pictures.
 The values for weight and dimensions are approximate.
 E.&O.E. Design and specifications subject to change without notice.



DISTRIBUTED BY



Hachioji Business Center of Victor Company of Japan, Ltd. has received ISO9001 Certifications.