

JVC[®]

The Perfect Experience / —
/

ProHD

HD Memory Card Camera Recorder

GY-HM100U

Unprecedented Mobility



SD[™]
HC
CLASS 6

Is it possible?



**Reliable &
Cost-Efficient
Storage**

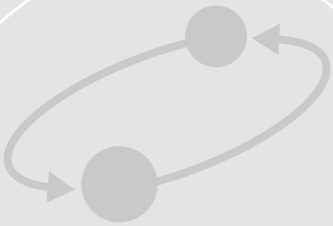

**Native NLE File
Format Recording**



**High Bit Rate
Encoding**



Super Portability

GY-HM100U

At Last, a Pro Camcorder that Speaks the Same Language as Your Editing System

Ready-to-edit MP4 files are compatible with every major editing system plus the world's first native support for Final Cut Pro™

The GY-HM100U is the first of a new generation of memory card camcorders designed to integrate seamlessly into the video production workflow. Native support for Apple's QuickTime™ file format means that you can bring footage into Final Cut Pro™ for editing directly without file conversion: no delays and absolutely no loss of quality. MP4 support means that you can edit your files on most major editing systems with the same astonishing quality. With low-cost media and a lightweight, compact body, you have a handheld camcorder that meets the needs of enthusiasts and professionals alike.



JVC Makes it Possible



Native File Recording

Record footage directly in ready-to-edit QuickTime™ MOV files, the native file format of Apple's Final Cut Pro™—simply drag the files into the timeline and start editing. Alternatively, you can record MP4 files that are compatible with all major editing systems.



Reliable, Low-Cost Media

The GY-HM100U uses standard, inexpensive and widely available SDHC Class 6 memory cards. These cards are small, light, robust and reliable, and can be read by your computer using any standard card reader.



Workflow

Until now, the camcorder has often been the main obstacle to achieving a smoother, more streamlined production workflow. Getting footage into a file format that your editing system could understand was a time consuming and laborious process. With Native File Recording, your footage is ready to edit the moment it's shot.

Shooting

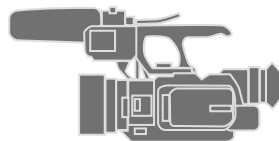

Transfer



MOV
or
MP4



MOV
or
MP4

**35
Mbps**

Exceptional Quality

Encoding video at higher bit-rates means just one thing: a higher quality picture. The 35 Mbps data rate used by the GY-HM100U is significantly higher than most other handheld camcorders and results in beautifully rich, broadcast-standard HD images.



True Portability

The GY-HM100U is truly an engineering marvel. Weighing only 3.1 lbs. (1.4 kg), this super-compact camcorder can be held comfortably with one hand. Go-anywhere portability makes this the ideal choice for location shooting in even the most difficult of environments.

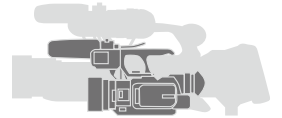

Editing

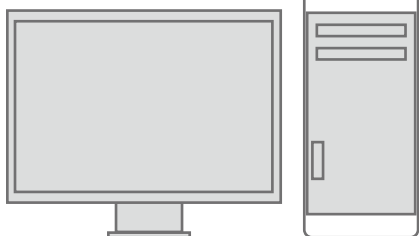

Storage

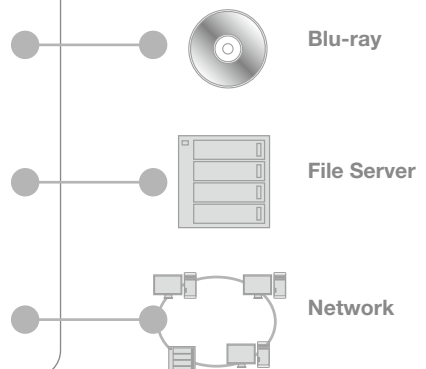



1080p Dynamic Digital Signal Processor (DDSP)

JVC's new Dynamic Digital Signal Processor is the engine that drives the GY-HM100U. This highly efficient MPEG2 encoder processes video signals at up to 35 Mbps for full progressive or interlace 1920 x 1080 HD video.

Handheld Portability with Stunning Quality GY-HM100U

Rotary Optical Image Stabilizer

With the increased resolution of HD pictures, even a small amount of camera shake becomes noticeable to the viewer. The newly developed Rotary Optical Image Stabilizer (ROIS) corrects for camera shake with no loss of image resolution or quality.

10x Fujinon HD Lens

The GY-HM100U is equipped with a high definition 10x zoom lens by Fujinon, a world leader in HD lens technology. In keeping with the overall design philosophy of the camcorder, the lens is designed to maximize optical performance while minimizing size and weight.

Three 1/4-inch Progressive CCD Design with Diagonal Offset

High definition is all about image quality. The combination of newly designed 1/4" progressive CCDs and JVC's Diagonal Offset technology delivers pristine HD pictures with rich, lifelike color.



Focus Assist

When shooting to HD, accurate focusing is critical. JVC developed Focus Assist to make accurate HD focusing quick and easy. When Focus Assist is switched on, the image in the viewfinder or LCD monitor becomes monochrome and all objects that are in focus appear with colored edges.

2.8-inch LCD Monitor

The 2.8-inch 16:9 aspect ratio LCD monitor provides not only an alternative to the viewfinder when shooting, it also displays a wide array of monitoring and setup indications.



Twin SDHC Card Slots

The GY-HM100U gives users the flexibility of twin SDHC memory card slots. When the card in the first slot is full, the camcorder switches automatically to the second with no drop out. Memory cards are hot swappable, so cards can be removed for editing without interrupting the shoot.

Advanced Technologies for Today's Users

The Next Generation of Direct File Access

Dual Format Recording (QuickTime™ for FCP™/MP4)

Because it uses QuickTime™ as its native file format, the GY-HM100U is the perfect choice for users of Apple's popular Final Cut Pro™ editing system. The MOV files recorded by the camcorder can be dragged directly into Final Cut Pro™, keeping them first-generation and eliminating the time-consuming process of file conversion. You'll

spend less time preparing the files for editing, and more time letting your creativity get to work. For users of other NLE systems, including solutions from Adobe, Avid and Canopus, the GY-HM100U also supports the MP4 file format. These files too can be brought into your editing system without re-encoding.

Dual Format Recording (QuickTime™ for FCP™/MP4)

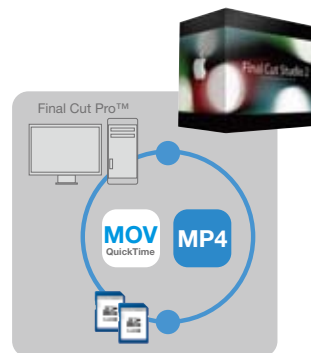

Twin SDHC Card Slots with Continuous Recording

With the advent of high capacity, affordable memory cards, extended shooting times have become a reality. The GY-HM100U goes a step further with twin SDHC card slots and the ability to shoot continuously from the first card to the second. No breaks in the recording, no momentary dropout—just one seamless take as the camcorder automatically switches to the second card when the first one is full. Further benefits of having two card slots include being able to make effective use of lower capacity cards, being able to hot-swap out the first card for editing while still shooting to the second, and the flexibility of scene-by-scene card selection.

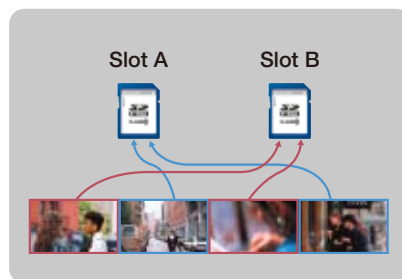

SDHC media offers the best combination of price, availability, capacity, reliability and transfer speed. With no moving parts and no pins or other extrusions, SDHC cards are both durable and reliable, and compare favorably with tape on a cost-per-minute basis.

Advanced MPEG2 High Bit Rate Encoding

1080p Dynamic Digital Signal Processor (DDSP)

At the heart of the GY-HM100U is a new Dynamic Digital Signal Processor. Processing is performed on the full progressive 1920 x 1080 signal, regardless of the camcorder's settings, ensuring the highest picture quality in any shooting mode. All major HD resolutions are supported, including 1920 x 1080, 1440 x 1080 and 1280 x 720.



35 Mbps MPEG2 Encoding

The highly efficient MPEG2 codec compresses video signals at up to 35 Mbps—high enough to support full 1920 x 1080 resolution—for simply stunning image quality. The MPEG2 long GOP (Group of Pictures) codec is a widely used, broadcast-standard compression system and is supported by all popular editing systems and broadcast servers.

35 Mbps

35 Mbps		25 Mbps	19 Mbps
1920 x 1080/60i	1280 x 720/60p	1440 x 1080/60i	1280 x 720/60p
1920 x 1080/50i	1280 x 720/50p	1440 x 1080/50i	1280 x 720/50p
1920 x 1080/30p	1280 x 720/30p		1280 x 720/30p
1920 x 1080/25p	1280 x 720/25p		1280 x 720/25p
1920 x 1080/24p	1280 x 720/24p		1280 x 720/24p
1440 x 1080/60i (MOV only)			
1440 x 1080/50i (MOV only)			

Uncompressed Audio Recording with Manual Controls

The GY-HM100U captures audio with the same uncompromising quality as video. Two-channel 16-bit/48 kHz uncompressed linear PCM can be recorded via the built-in stereo ambient microphone and the detachable shotgun microphone, or via a pair of balanced XLR connectors. Versatile input switching and independent channel assignment allow both mic and line-level sources (such as wireless receivers) to be connected, and phantom power is available on each XLR connector independently. Audio recording levels can be controlled automatically or manually, and there's an audio level meter in the viewfinder and LCD monitor for easy monitoring.

linear PCM Recording



Professional Quality HD Recording

10x Fujinon HD Lens

The JVC GY-HM100U is equipped with a high definition 10x zoom lens by Fujinon, a world leader in HD lens technology. The design minimizes the weight and size of the lens, while still providing exceptional HD optical performance, with low distortion. To reduce lens flare and ghosting, the lens surface has a new Electronic Beam Coating (EBC) that greatly reduces the amount of light reflecting off the lens surface, and increases light transmission.



The focal length of the lens ranges from 3.7–37 mm (39–390 mm at 35 mm film equivalents), offering a good balance of wide angle and zoom. For wider angle shooting, the built-in lens hood can be removed and an optional GL-V0746U wide-angle converter fitted. The zoom range can also be extended with the optional GL-V1846U telephoto converter.



Three 1/4-inch Progressive CCD Design with Diagonal Offset

The three progressive CCD design provides rich, accurate colors, while JVC's Diagonal Offset technology increases sampled luminance information in both horizontal and vertical directions by shifting the red and blue pixels relative to the green. The result is a sharper picture without any corresponding loss in sensitivity.

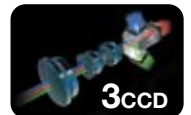

Rotary Optical Image Stabilizer

With the increased resolution and sharpness of HD pictures, even a small amount of camera shake becomes noticeable to the viewer. JVC's newly developed Rotary Optical Image Stabilizer (ROIS) corrects for lateral and vertical movement of the camera without the degradation of image quality associated with digital image stabilization systems. The result is pristine HD images that remain sharp and stable.

Still Picture Capture

The GY-HM100U doubles as a very capable 2-Megapixel still-picture camera. You can capture pictures live or from video that is already recorded, and store them to either of the on-board memory card. What's more, because the CCDs are progressive, every frame is sharp and clear, even when there is movement in the scene.

Manual Versatility, Automatic Flexibility

Shooter-Friendly Controls and Layout

Ergonomics has played a major role in the design of the GY-HM100U. The camera's handgrip makes the camera very comfortable to hold for any operator, even on long shoots.

And despite its extremely compact dimensions, all the camcorder's main functions are accessible directly from controls and switches on the camera body, right where you would expect them to be.



- **Lens zoom/Focus selector**
- **White balance**—selectable between preset and two user settings
- **Gain** (L,M,H)
- **Full auto** (on/off)
- **Auto/Manual focus**
- **ND filter** (OFF, +1/10ND)
- **User1/User2/User3** (allows user to predefine functions such as Focus Assist, Color Bars, TC setting, LoLux, Zebra, Tele/Macro, etc.) **and so on.**

Focus Assist

With the increased resolution of HD, accurate focusing is critical—focusing errors that may pass unnoticed in SD video are far more obvious when watching in HD. JVC developed Focus Assist to make accurate HD focusing quick and easy. When Focus Assist is switched on, the image in the viewfinder or LCD monitor becomes monochrome and all objects that are in focus appear with colored edges. Keeping the important elements in the picture in focus while shooting is greatly simplified.



Out-of-focus image



In-focus image

The edge of the in-focus subject is shown in color, telling the operator that the subject is in-focus. A major benefit of this system is that it operates in real time.

Comprehensive Auto Functions

In most ordinary shooting situations the automatic functions of the GY-HM100U take care of the technicalities, letting you focus on the action in the frame and getting the shot the way you want it.

2.8-inch LCD Monitor

The 2.8-inch 16:9 aspect ratio LCD monitor provides not only an alternative to the viewfinder when shooting, it also displays a wide array of monitoring and setup indications. To the left of the screen is a mini joystick and push button for navigating menus and selecting options, as well as a zoom control and a recording start/stop button.



Versatile Manual Functions

For greater creativity and control, many of the camcorder's functions can be controlled manually, from shutter speed and exposure to horizontal and vertical image detail, gamma adjustment and brightness gain. Manual control can open the door to some great special effects, as well as enabling better footage to be shot in challenging shooting environments.

- **LoLux mode** — a JVC exclusive feature that permits shooting in adverse lighting conditions
- **H detail & V detail Adjustment**
- **KNEE Setting**
- **Zebra pattern** which range specification is possible
- **Color matrix/Gain Adjustment**
- **Gain settings** of 0,3,6,9,12,15,18 dB & AGC can be assigned to the "L/M/H" gain switch
- **Gamma Adjustment** which gives rich expression of gradation



Wireless Remote Control

The GY-HM100U comes with an infrared remote control for operating the camcorder remotely—great for static point-of-view shots when an operator is unavailable or unnecessary.



User-Friendly Functionality

Data Battery

The supplied JVC Data Battery provides over two hours of recording time. Using a JVC Data Battery not only guarantees excellent battery performance, it also enables you to monitor the remaining power and recording time, all at the touch of a button. Continuous recording time by the provided BN-VF823U battery is approximately 120 minutes with viewfinder and LCD monitor on at 25°C.



GUI

The new GUI, visible in both the LCD monitor and as an overlay in the viewfinder, features several improvements that make the GY-HM100U a pleasure to use. The high-resolution picture thumbnail display makes it a simple task to select clips visually for review, and more detailed file and shooting information for each clip is now available, including the file format, frame rate and resolution.



Video Output

For external monitoring or capture, the GY-HM100U is equipped with a variety of video output options, including HDMI™ and component output for HD or downconverted SD video, and composite output for SD video only. HDMI™ output is via a standard HDMI™ connector and can output full HD video as well as uncompressed audio.

HDMI™
HIGH-DEFINITION MULTIMEDIA INTERFACE

	HD	SD
HDMI™	720p or 1080i	Downconverted 480i/p or 576i/p
Component	720p or 1080i	Downconverted 480i or 576i
Composite	-	Downconverted 480i or 576i

No cross convert capability.
Output signal format is determined by System select and Connection setting in the menu.



AV (Composite) out
HDMI™ out
USB 2.0 out

Component out



GY-HM100U Editing Workflow

MOV File Workflow Direct file access to Apple's Final Cut Pro™

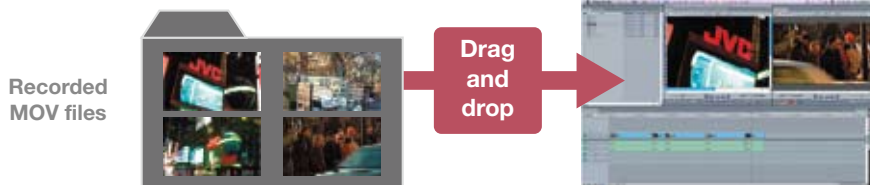
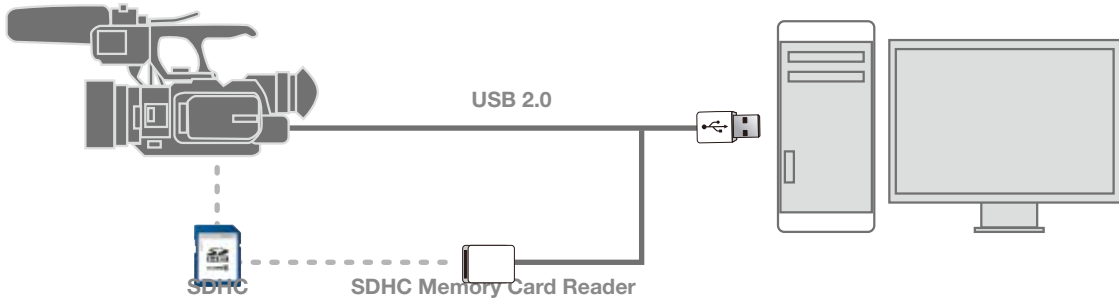

MP4 File Workflow Ingest MP4 clips to major NLE systems

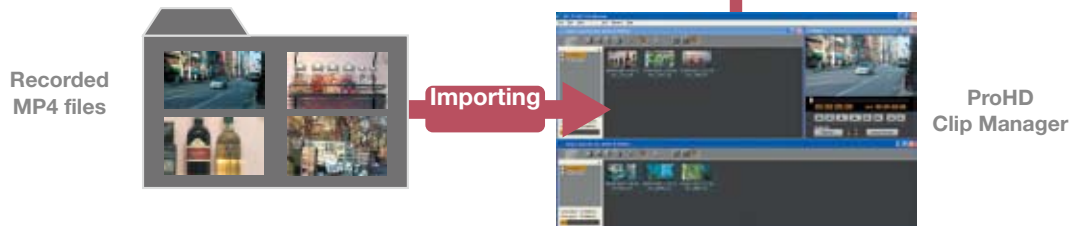
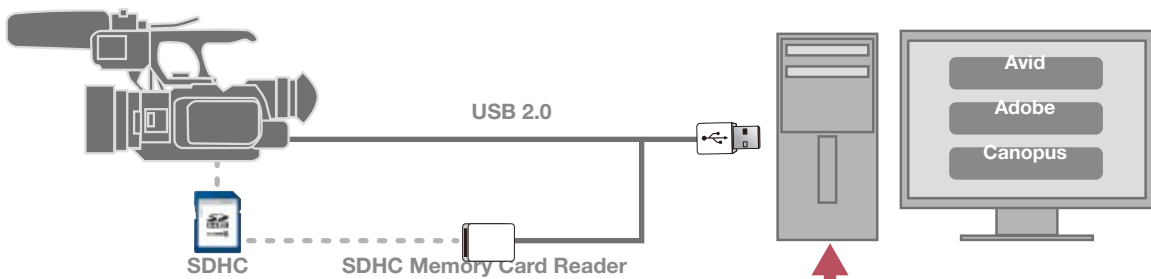

ProHD Software

JVC ProHD Clip Manager

The ProHD Clip Manager, for both Mac and Windows, makes it easy to manage MP4 clips on the GY-HM100U's memory cards from your PC. With a few clicks of the mouse you can copy, move or delete clips, preview clip content, as well as view and edit clip metadata. You can also manage folders to keep things organized, check the remaining space left on a card, and set the index frame of a clip to use as its thumbnail.

Main screen for Windows®

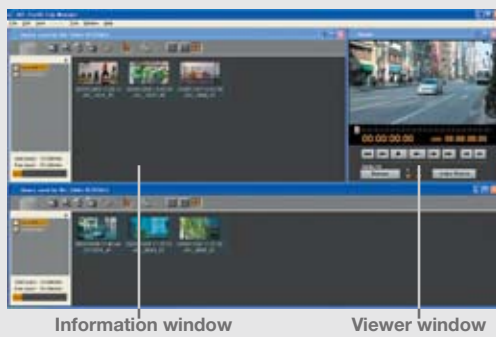

ProHD Log and Transfer Plug-in

The ProHD Log and Transfer Plug-in is a software for Apple's Final Cut Pro™ that lets you drop MP4 files recorded on the GY-HM100U into the clip bin of Final Cut Pro™. With the plug-in installed, you can view thumbnails of the MP4 files on a memory card from the Log and Transfer screen of Final Cut Pro™. Simply drag and drop the thumbnails into the bin to automatically convert the clips to QuickTime™ format, ready for use.

Log and transfer screen

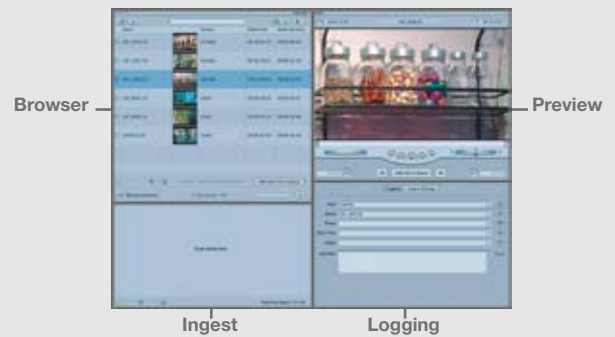

Dimensions

Unit: inches (mm)

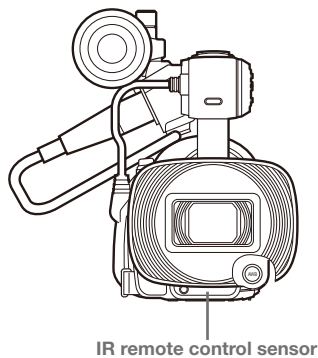
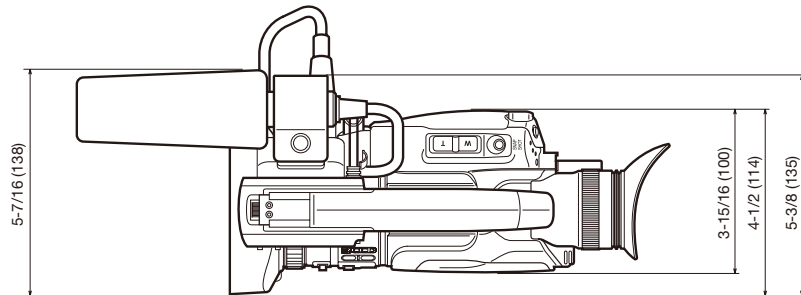

IR remote control sensor

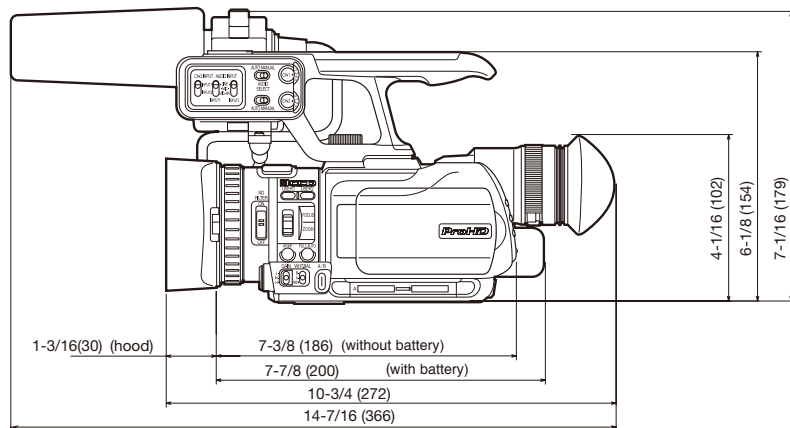

Specifications

GY-HM100U

[General]

Power requirement: DC 11 V (using AC adapter)/DC 7.2 V (using battery)
 Power consumption: 7.8 W (when LCD screen backlight is set to [STANDARD])
 Dimensions: 272 mm (W) x 179 mm (H) x 135 mm (D)
 (10-6/8" x 7-1/8" x 5-3/8")
 Mass: Approx. 1.4 kg (3.1 lbs.) (including battery BN-VF823, SDHC card and microphone)
 Temperature:
 Operating: 0°C to 40°C (32°F to 104°F)
 Storage: -20°C to 50°C (-4°F to 122°F)

Humidity:

Operating: 35 % to 80 % RH
 Image pickup device: 3-chip 1/4" Progressive CCD
 Color separation prism: 3-color separation prism
 Sync system: Internal sync (built-in SSG)
 Filter diameter:

When the hood is detached: 46 mm (screw pitch: 0.75 mm)
 Compatible with filter, tele-converter and wide-converter
 When the hood is attached: 72 mm (screw pitch: 0.75 mm)
 Compatible with filter only

Lens: Fujinon F1.8 to 2.8, 10x, f=3.7-37 mm (35 mm conversion: 39 to 390 mm)
 ND filter: OFF, +1/10ND

Gain: 0dB, 3dB, 6dB, 9dB, 12dB, 15dB, 18dB, Lolux, AGC
 Minimum illumination: 5lx (typical) (1920x1080 mode, F1.8, +18dB, with 16-frame accumulation)

Electronic shutter: 1/3.75 to 1/10000, EEI
 Viewfinder: 0.44" LCD, 235,000 pixels, 16:9
 LCD monitor: 2.8" LCD, 206,000 pixels, 16:9

Supported media: SDHC (Class 6)

Slots: x 2

Recording time: Approx. 25 minutes (8 GB SDHC card, 35 Mbps, VBR mode)

[Video/Audio]

Recording file format: QuickTime™ File Format for Final Cut Pro™/MP4 File Format

Recording format:

Video: MPEG-2 long GOP
 HQ mode: VBR, 35 Mbps (Max) MPEG-2 MP@HL
 SP mode: CBR, 25 Mbps (1440x1080i)/
 19 Mbps (1280 x 720p24/25/30): MPEG-2 MP@H-14
 19 Mbps (1280 x 720p50/60): MPEG-2 MP@HL
 Audio: LPCM 2ch, 48 kHz/16bit

Video frame rate:

NTSC settings:
 HQ mode: 1920 x 1080/59.94i, 29.97p, 23.98p, 1440 x 1080/59.94i (MOV only), 1280 x 720/59.94p, 29.97p, 23.98p
 SP mode: 1440 x 1080/59.94i, 1280 x 720/59.94p, 29.97p, 23.98p
 PAL settings:
 HQ mode: 1920 x 1080/50i, 25p, 1440 x 1080/50i (MOV only), 1280 x 720/50p, 25p
 SP mode: 1440 x 1080/50i, 1280 x 720/50p, 25p

[Still Picture]

Still picture recording format: JPEG
 Recording size: 4 modes (1920 x 1080/1440 x 1080/1024 x 768/640 x 480)
 Recording quality: 2 modes (Fine, Standard)

[Connectors]

AV output: Video analog composite output (480i or 576i: Downconverted, 4:3/16:9): 1.0 V (p-p), 75-ohms, Audio Stereo, analog output 300 mV, 1 k-ohms (Special cable)

Component output: Y, Pb, Pr component output (480i or 576i:

Downconverted/720p/1080i)

Y: 1.0 V (p-p), 75-ohms

Pb, Pr: 0.7 V (p-p), 75-ohms (Special cable)

HDMI™ output: HDMI™(480i/p or 576i/p: Downconverted/720p/1080i) (V.1.3, x.v. Color compliant)

USB: Mini USB-B type, USB 2.0

Headphone: 3.5 mm mini-jack (stereo)

Microphone: 3.5 mm mini-jack (stereo)

Audio input:

[MIC]: -60 dBs, 3 k-ohms, XLR (balanced), +48 V output (phantom power supply)

[LINE]: +4 dBs, 10 k-ohms, XLR (balanced)

[Accessories Provided]

Battery pack (BN-VF823) x 1, AC adapter (AP-V21) x 1,
 Battery charger (AA-VF8) x 1, Microphone x 1, Wireless remote control unit x 1,
 Component cable x 1, A/V cable x 1, USB cable x 1

■ SDHC Class 6 recording time (approx.)

	MOV/MP4		
	SP		HQ
	720p	1080i	720p/1080i
4GB	22 min.	17 min.	12 min.
8GB	45 min.	35 min.	25 min.
16GB	1 hr. 30 min.	1 hr. 10 min.	50 min.
32GB	3 hr.	2 hr. 20 min.	1 hr. 40 min.

Optional Accessories



GL-V0746U
0.7x Wide converter



GL-V1846U
1.8x Tele converter



BN-VF823U
Battery



AA-VF8U
Battery charger



MV-P615U
Super direction microphone



MZ-V8U
Stereo microphone

Final Cut Pro™ is not supplied.
 Microsoft® and Windows® are either registered trademarks or trademarks of Microsoft Corporation in the United States and/or other countries. Apple, Apple logo, Macintosh, QuickTime, and Final Cut Pro are trademarks of Apple Inc. registered in the United States and other countries. The SD and SDHC logos are trademarks of the SD Card Association. Product and company names mentioned here are trademarks or registered trademarks of their respective owners.

Simulated pictures.

The values for weight and dimensions are approximate.
 E.&O.E. Design and specifications subject to change without notice.

JVC®

DISTRIBUTED BY



Hachioji Business Center of Victor Company of Japan, Ltd.
 has received ISO9001 Certifications.